

画像情報特論 (1)

Advanced Image Information (1)

Introduction and Streaming Background

情報理工・情報通信専攻 甲藤二郎

Dept. of Computer Science and Engineering, Jiro Katto

E-Mail: katto@waseda.jp

Introduction

TCP Variants

- Loss-based

- Delay-based

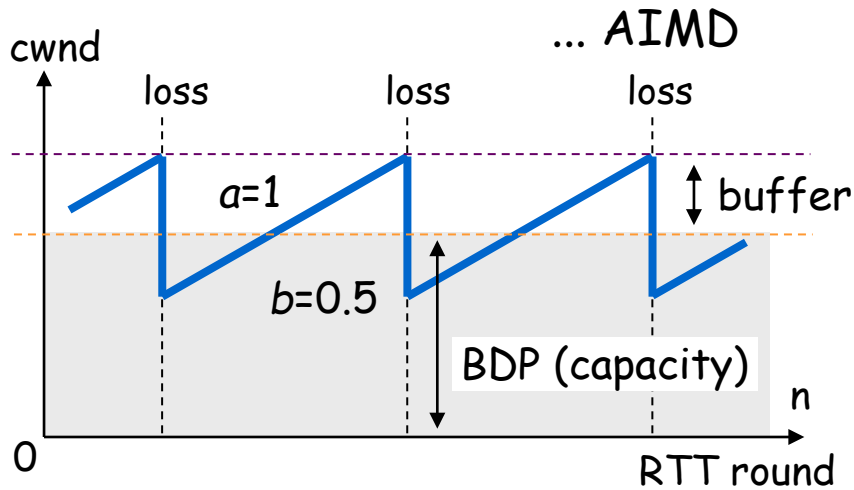

TCP-Reno, High-Speed TCP,
TCP-Westwood, CUBIC-TCP, ...

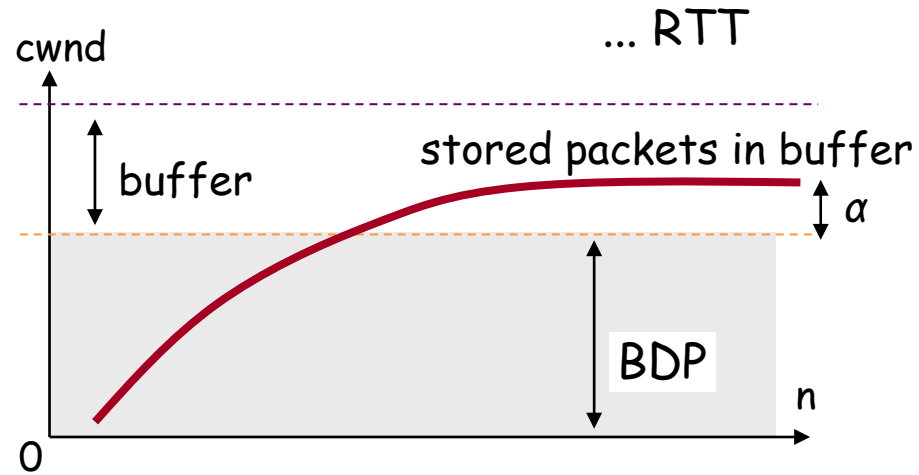

TCP-Vegas, FAST-TCP

- Hybrid Compound TCP

- TCP-BBR

RTP and TFRC

■ TFRC (over RTP/UDP)

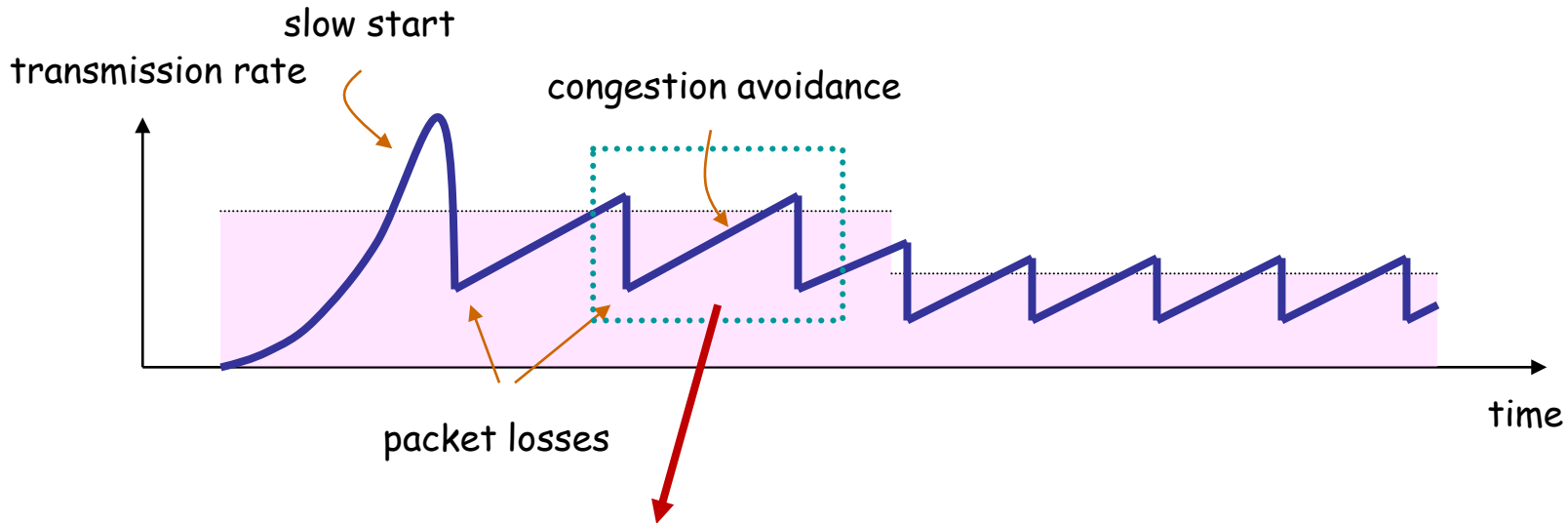

Modeling of steady-state
TCP behaviors

$$R = \frac{1}{RTT} \sqrt{\frac{3}{2p}}$$

p: packet loss rate

BDP/Buffer relationship

small buffer → × efficiency
large buffer → × delay



HTTP and MPEG-DASH

- MPEG-DASH: Dynamic Adaptive Streaming over HTTP
 - Multiple (bitrate, resolution) pairs ... representation
 - Adaptive selection of representations

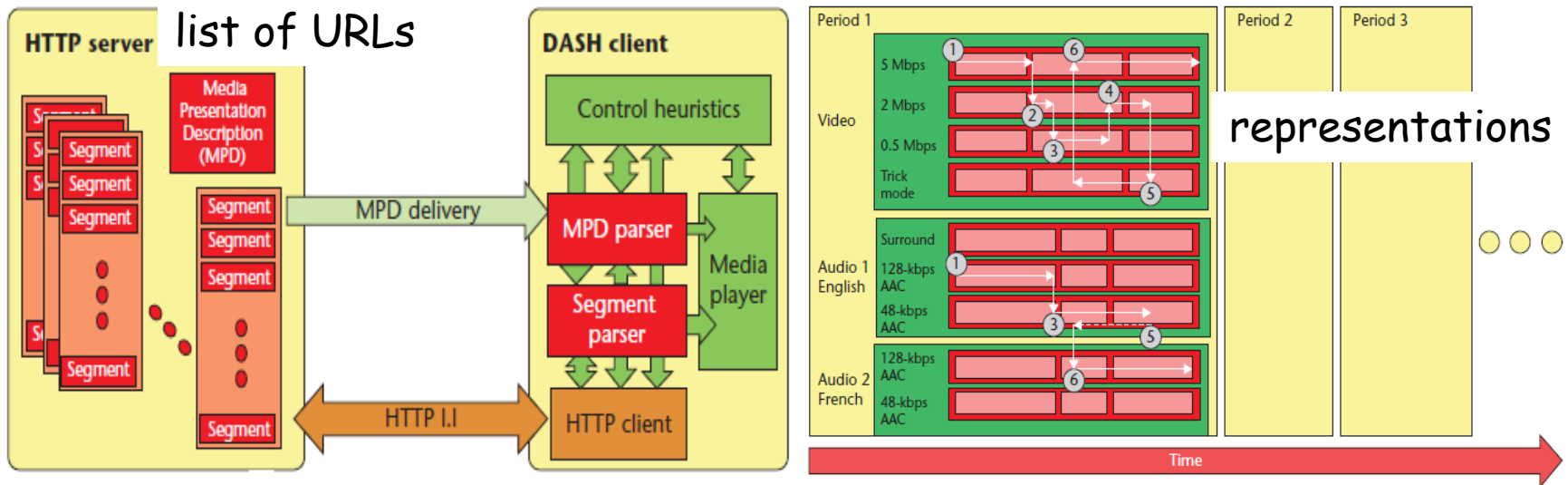

CDN, P2P & Cloud

■ Overlay networks

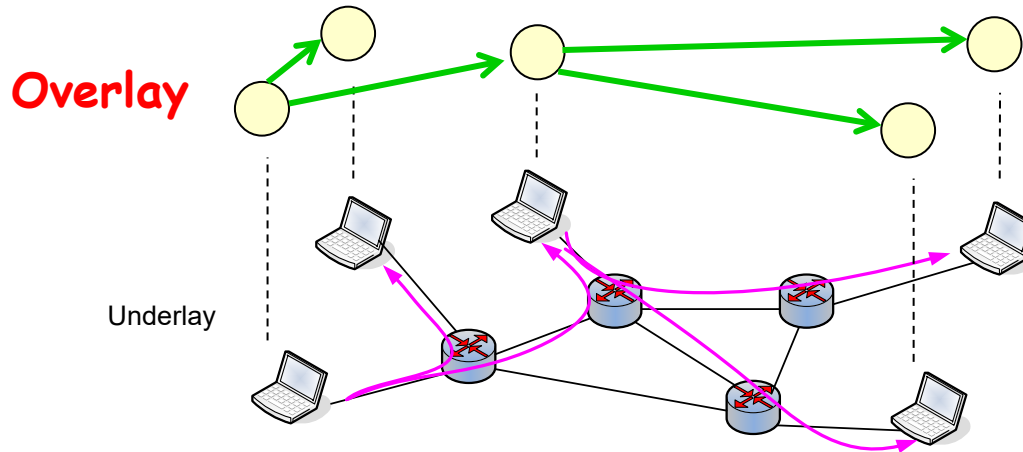

■ tree

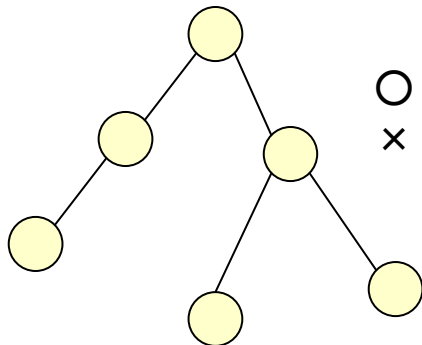

○ complexity
× robustness

■ mesh

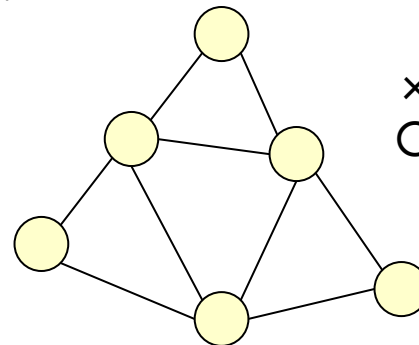

× complexity
○ robustness

SIP and WebRTC

■ SIP: Session Initiation Protocol

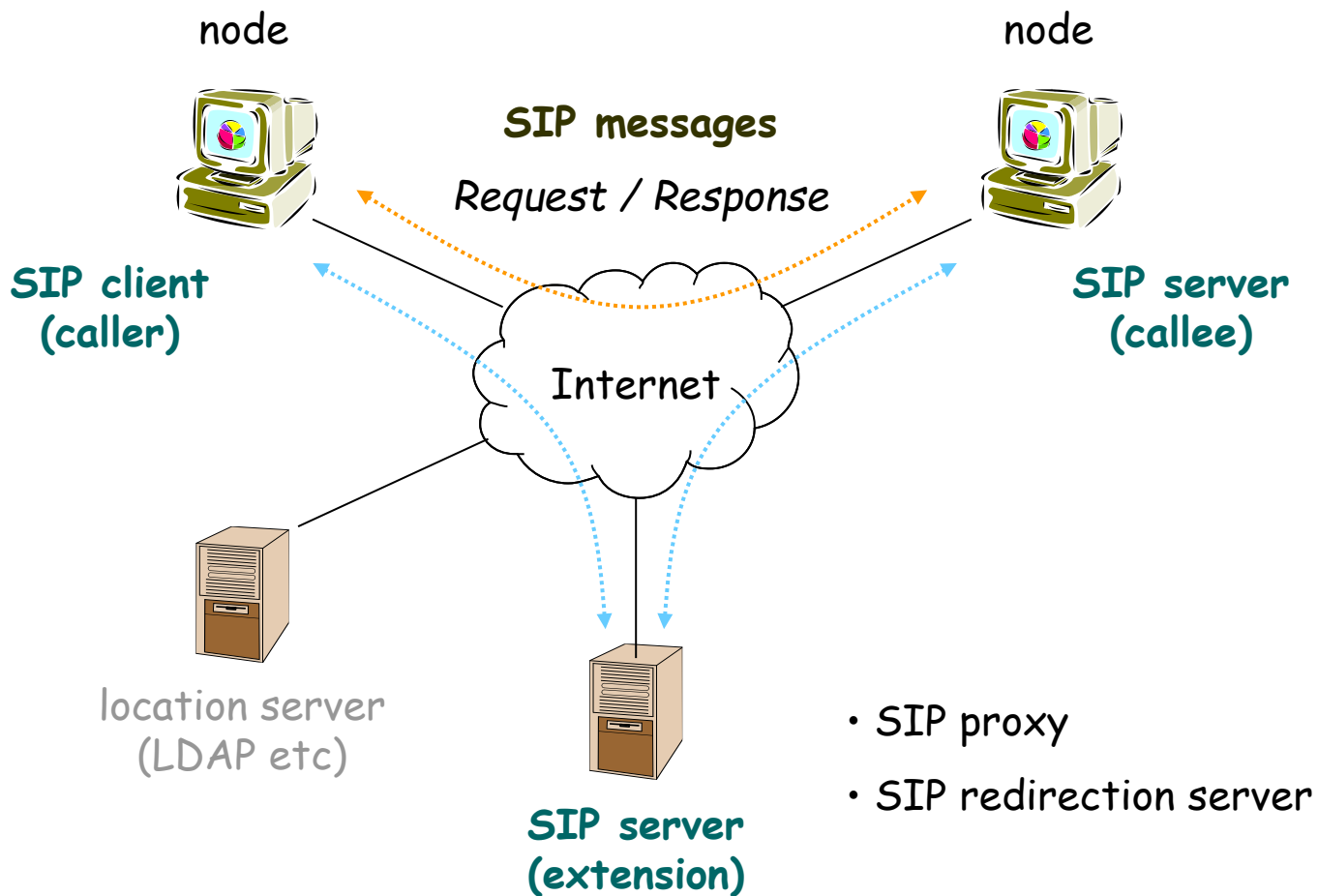

Video Compression Basics

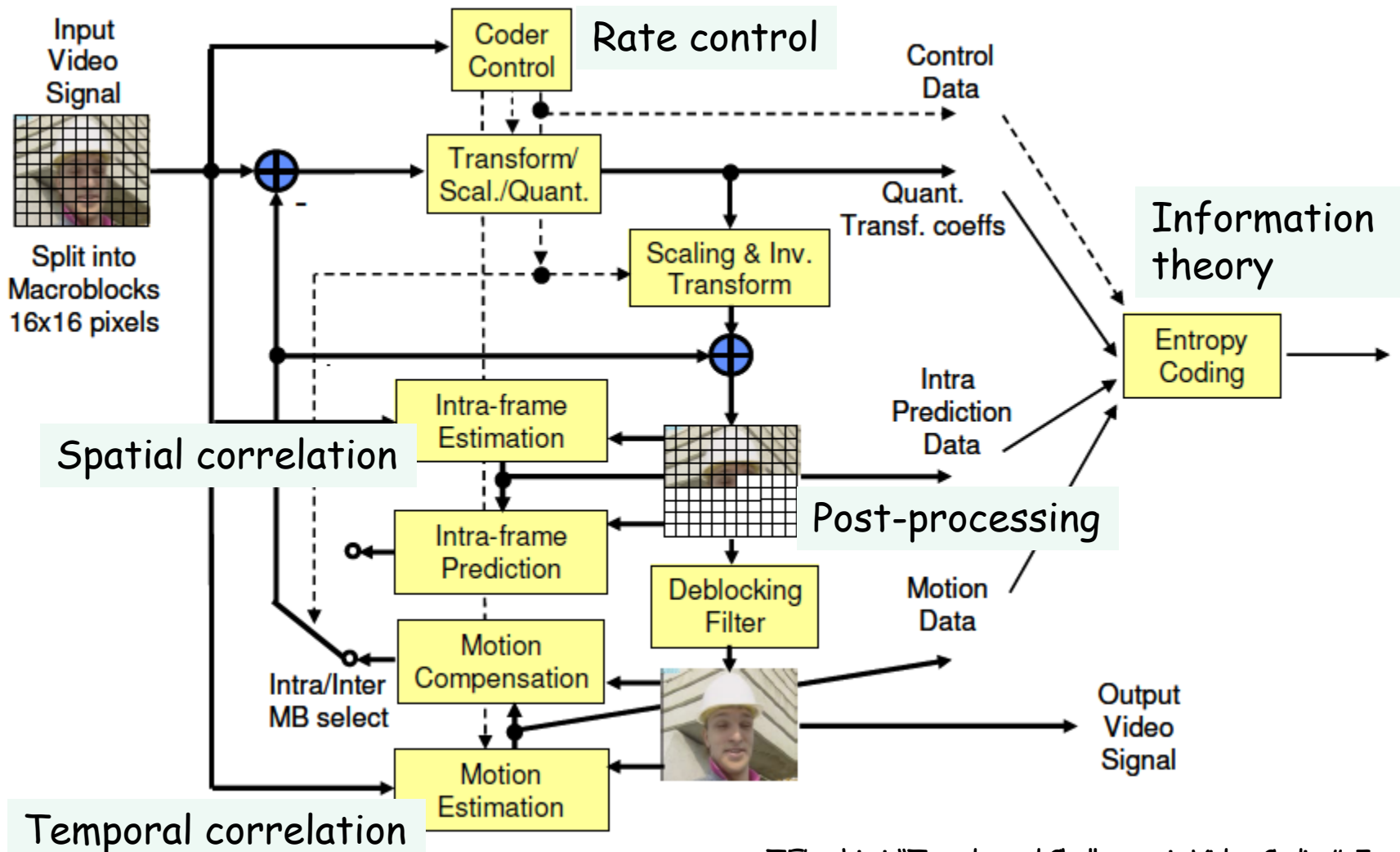

Video Compression History

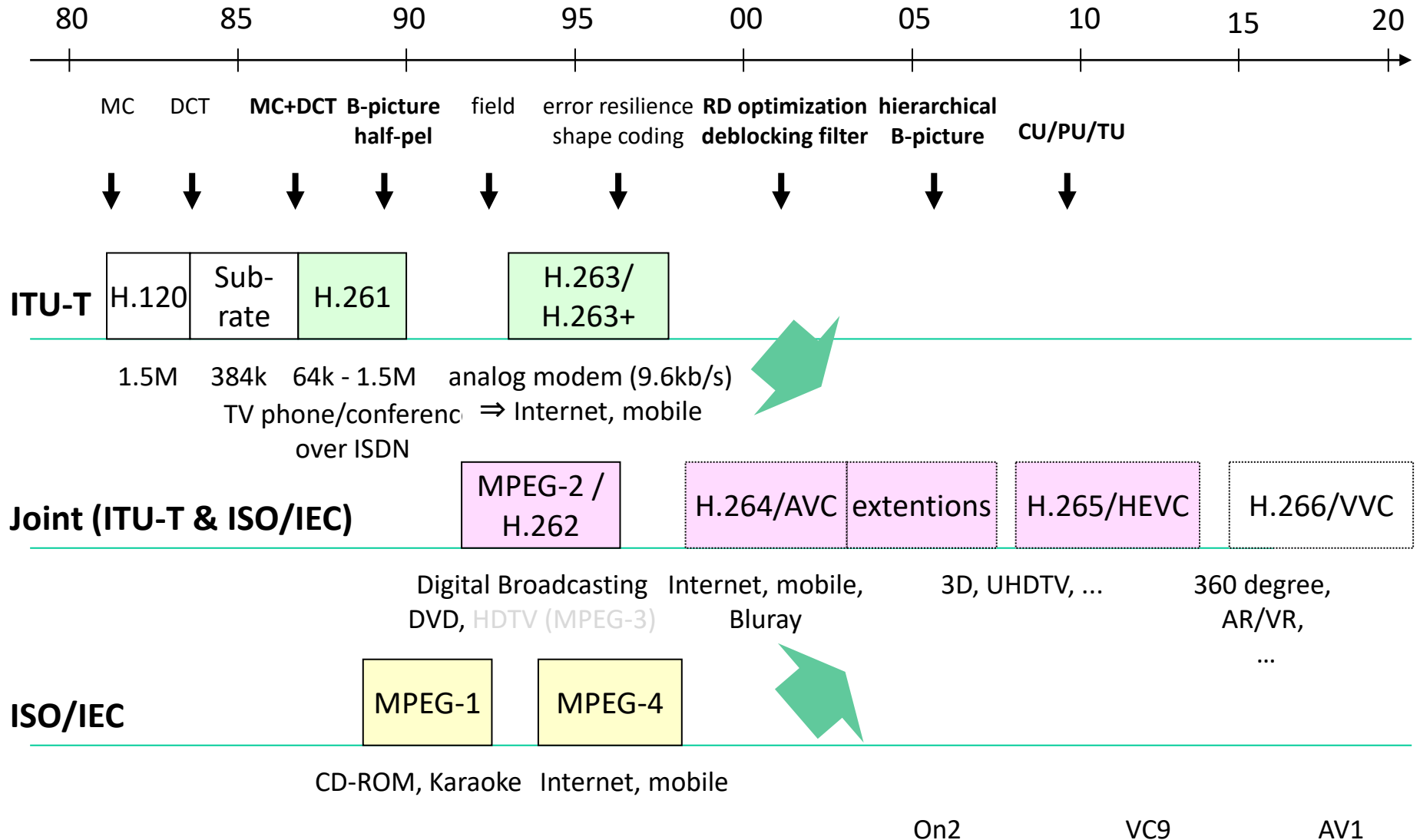

Learned Image Compression

- Active topics in these five years

Compression performance

International standard for image compression

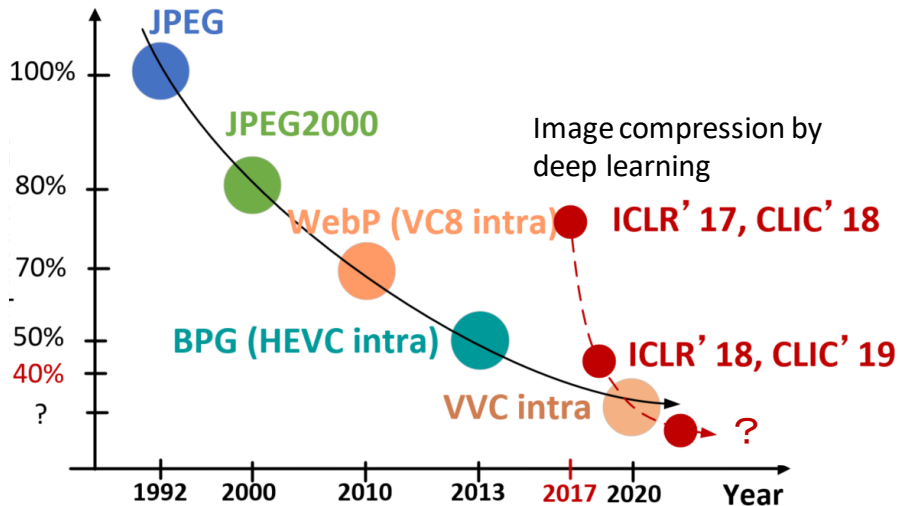

CLIC in CVPR

CLIC WORKSHOP CHALLENGE LEADERBOARD CALL FOR PAPERS ABOUT

WORKSHOP AND CHALLENGE ON LEARNED IMAGE COMPRESSION (CLIC)

Introduction

Our workshop aims to gather publications which will advance the field of image compression with and without neural networks. Even with the long history of signal-processing oriented compression, taking new approaches to image processing have great potential, due to the proliferation of high-resolution cell-phone images and special hardware (e.g., GPUs). The potential in this area has already been demonstrated using recurrent neural networks, convolutional neural networks, and adversarial learning, many of these matching the best image-compression standards when measured on perceptual metrics. As such, we are interested in the various techniques associated with this class of methods. Broadly speaking, we would like to encourage the development of novel encoder/decoder architectures, novel ways to control information flow between the encoder and the decoder, and learn how to quantize (or learn to quantize) better.

Important Dates

Date	Description
December 22nd, 2017	Challenge announcement and the training part of the dataset released
January 15th, 2018	The validation part of the dataset released, online validation server is made available
April 15th, 2018	The test set is released
April 22nd, 2018	The competition closes and participants are expected to have submitted their decoder and compressed images
April 26th, 2018	Deadline for paper submission
May 29th, 2018	Release of paper reviews and challenge results

<http://www.compression.cc/>

Image Quality Assessment

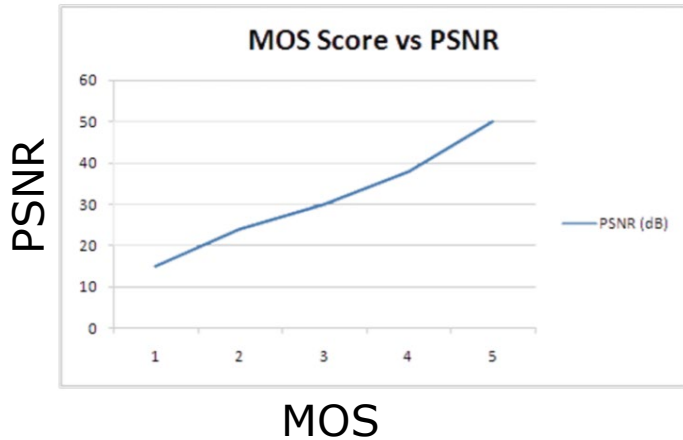

There exists strong correlation between MOS and MSE but not enough

(b)-(g) images have the same MSEs, but subjective impressions are different

(h)-(l) images are scaled, shifted or rotated, and have different MSEs



[FIG2] Comparison of image fidelity measures for "Einstein" image altered with different types of distortions. (a) Reference image. (b) Mean contrast stretch. (c) Luminance shift. (d) Gaussian noise contamination. (e) Impulsive noise contamination. (f) JPEG compression. (g) Blurring. (h) Spatial scaling (zooming out). (i) Spatial shift (to the right). (j) Spatial shift (to the left). (k) Rotation (counter-clockwise). (l) Rotation (clockwise).

Point Cloud Compression

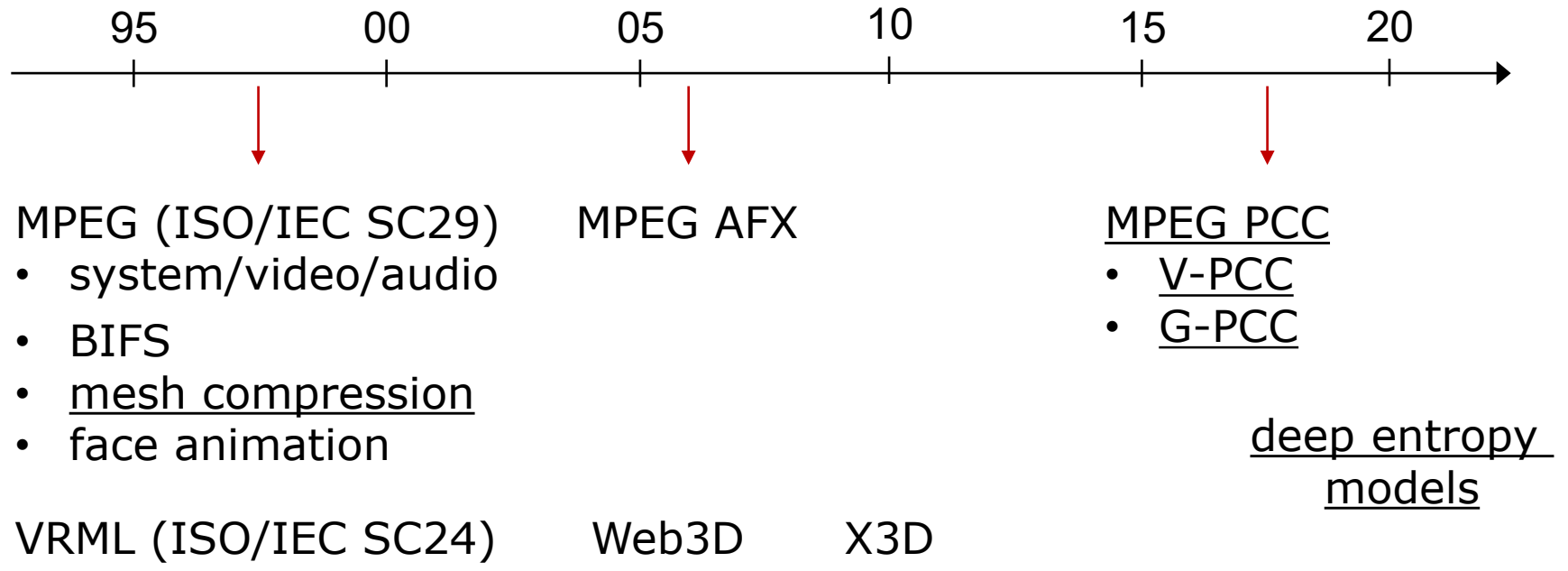

BIFS: BInary Format for Scene description

VRML: Virtual Reality Modeling Language

AFX: Animation Framework eXtension

PCC: Point Cloud Compression

V-PCC: Video-based PCC

G-PCC: Geometry-based PCC

EVC, AVS, and AV1

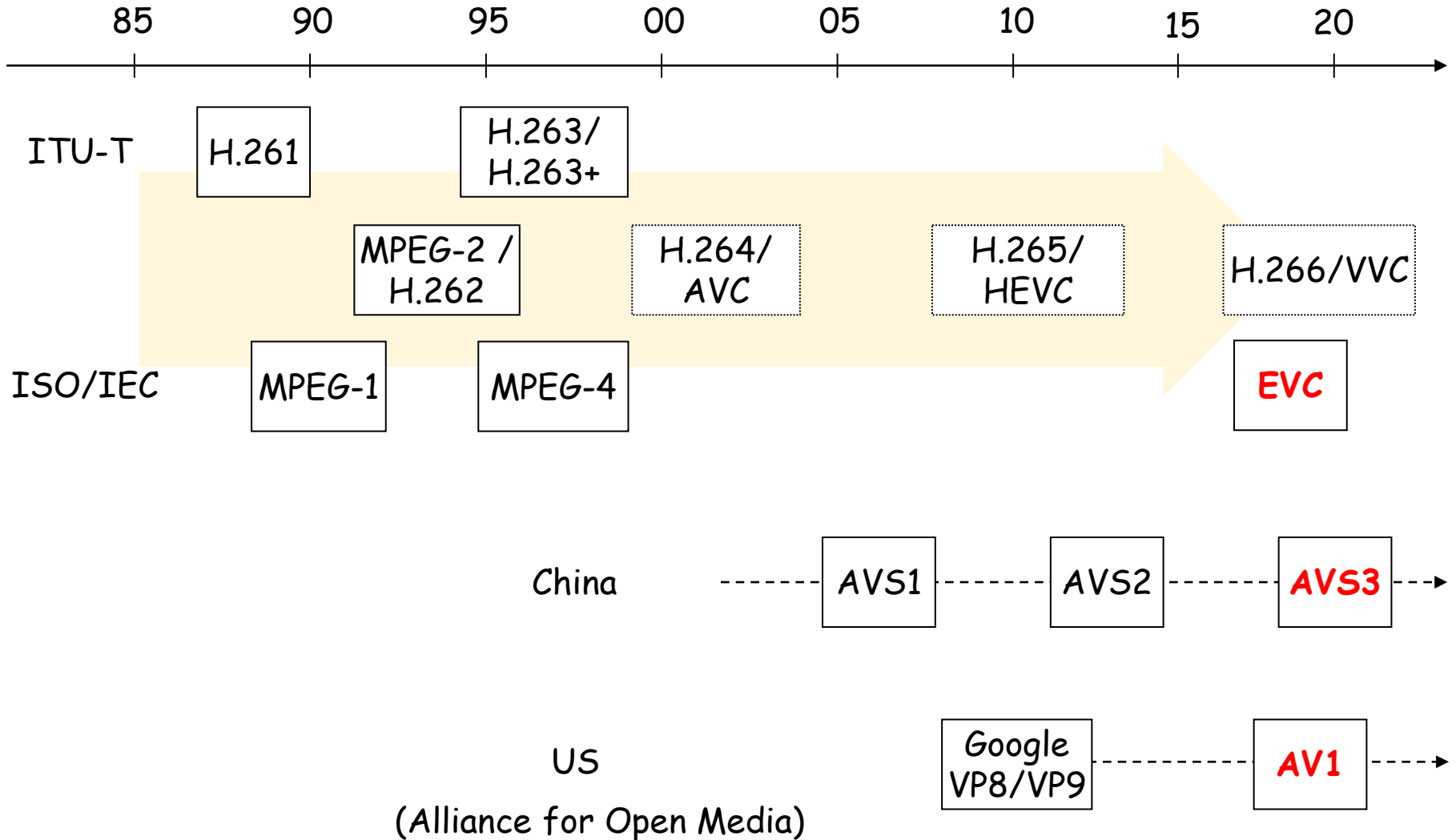

Streaming Background

Recent Trends

- Drastic Increase of Video Traffic on Internet
 - more than 70%

- Evolution of Various Video Services
 - higher resolution and personalization

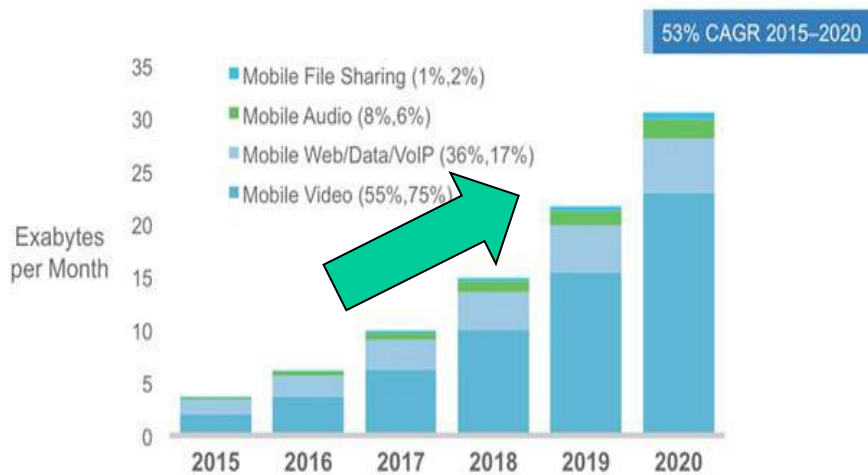

(Cisco VNI, 2016)

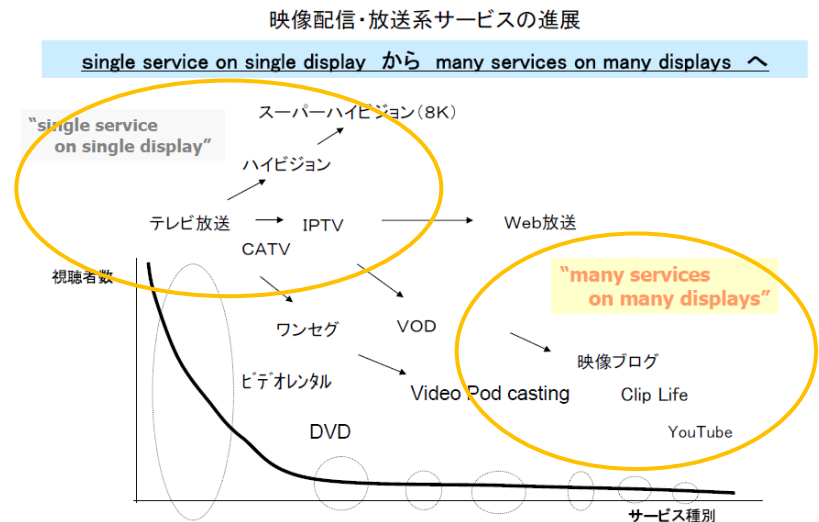

(MIC Report, 2008)

History of Video Streaming

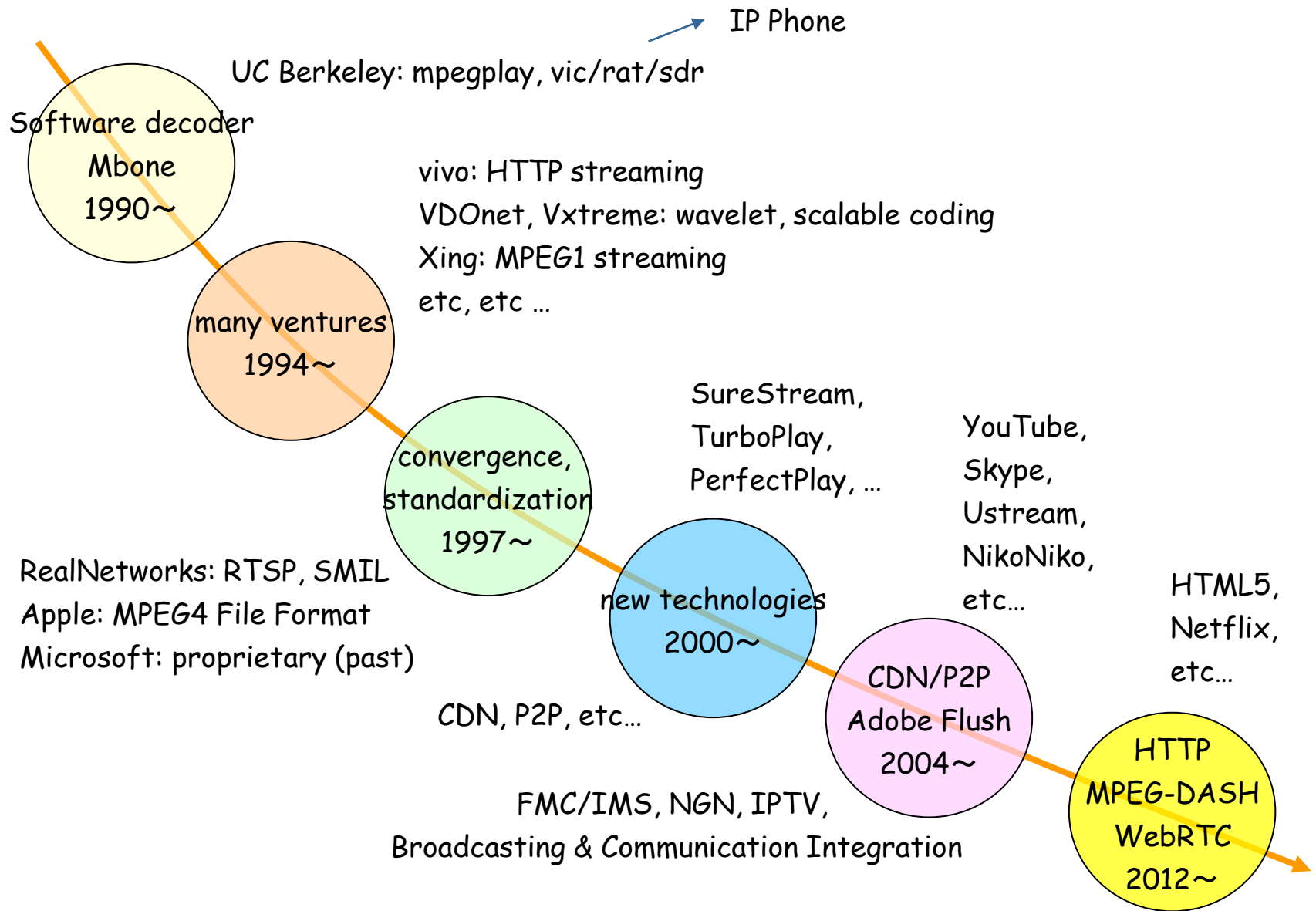

Protocol Stack of RTP/UDP Video Streaming (and IP phone)

protocol stack for low-delay & interactive video streaming (e.g. conference)

application (L7)	video (H.264 etc...)	audio	SDP	layout (HTML, SMIL)
adaptation	RTP / RTCP		RTSP, SIP, SAP*	HTTP
transport (L4)	UDP / TCP / DCCP		TCP / UDP / SCTP	
network (L3)	IP (IPv4, IPv6, IP-multicast)			
datalink & physical (L2 & L1)	actual networks (802.3 (ethernet), 802.11 (WiFi), etc)			

* SAP: delivered by IP-multicast for program advertisement

Protocol Stack of HTTP Video Streaming

protocol stack for one-way video streaming

application (L7)	video (H.264 etc...)	audio	MPD (MPEG-DASH)	layout (HTML)
adaptation	HTTP			
transport (L4)	TCP			
network (L3)	IP (IPv4, IPv6)			
datalink & physical (L2 & L1)	actual networks (802.3 (ethernet), 802.11 (WiFi), etc)			

Protocol Stack of WebRTC

protocol stack for low-delay & interactive video streaming (e.g. conference)

NAT traversal

media

data

signaling

	video	audio	data	SIP, SDP
STUN, TURN	SRTP		SCTP/DTLS	HTTP/TLS, WebSocket
	UDP			TCP
	IP			
	MAC / PHY			

Networks and Multimedia

- Cat-and-mouse game

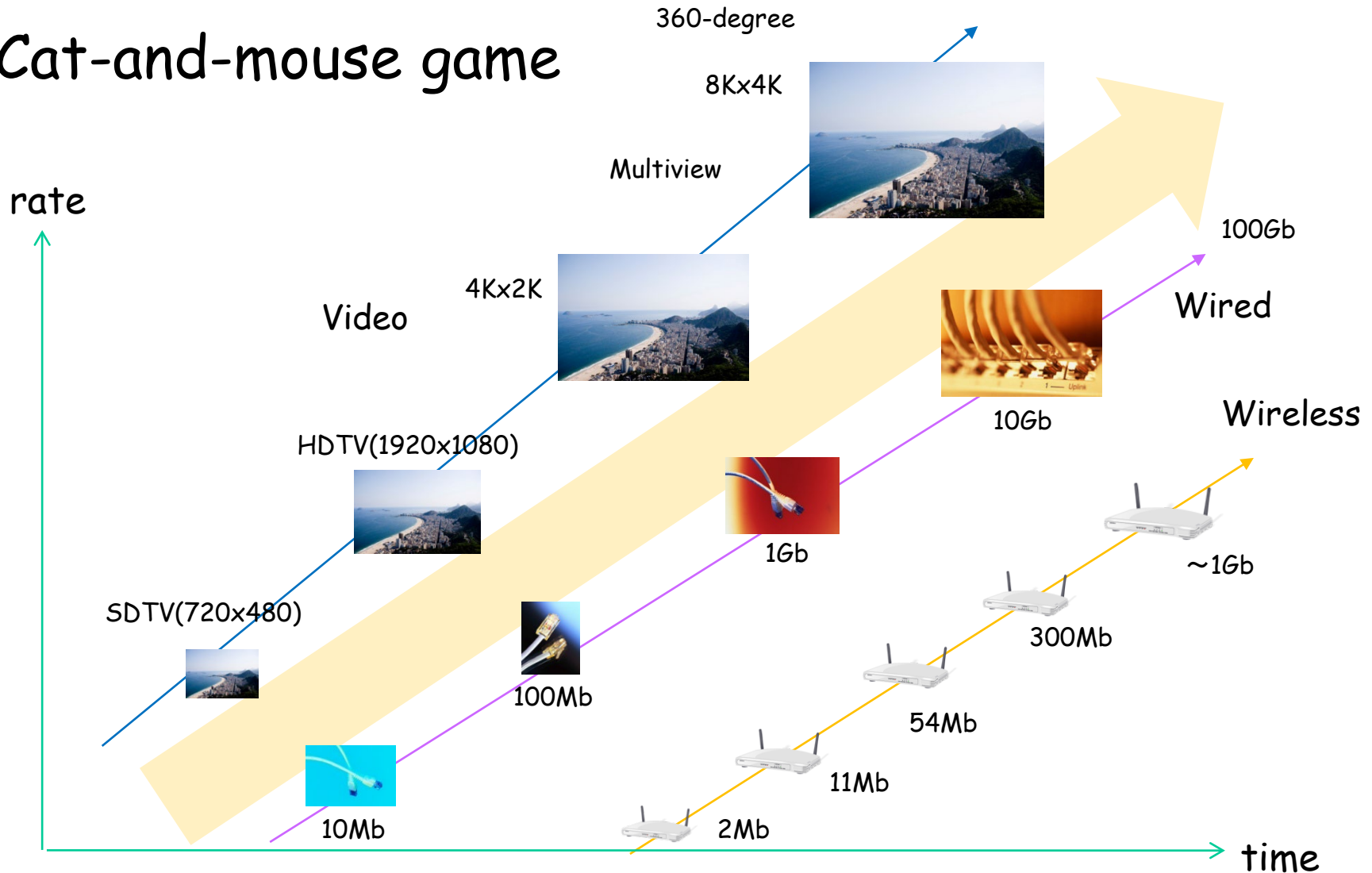

Broadband and CDN

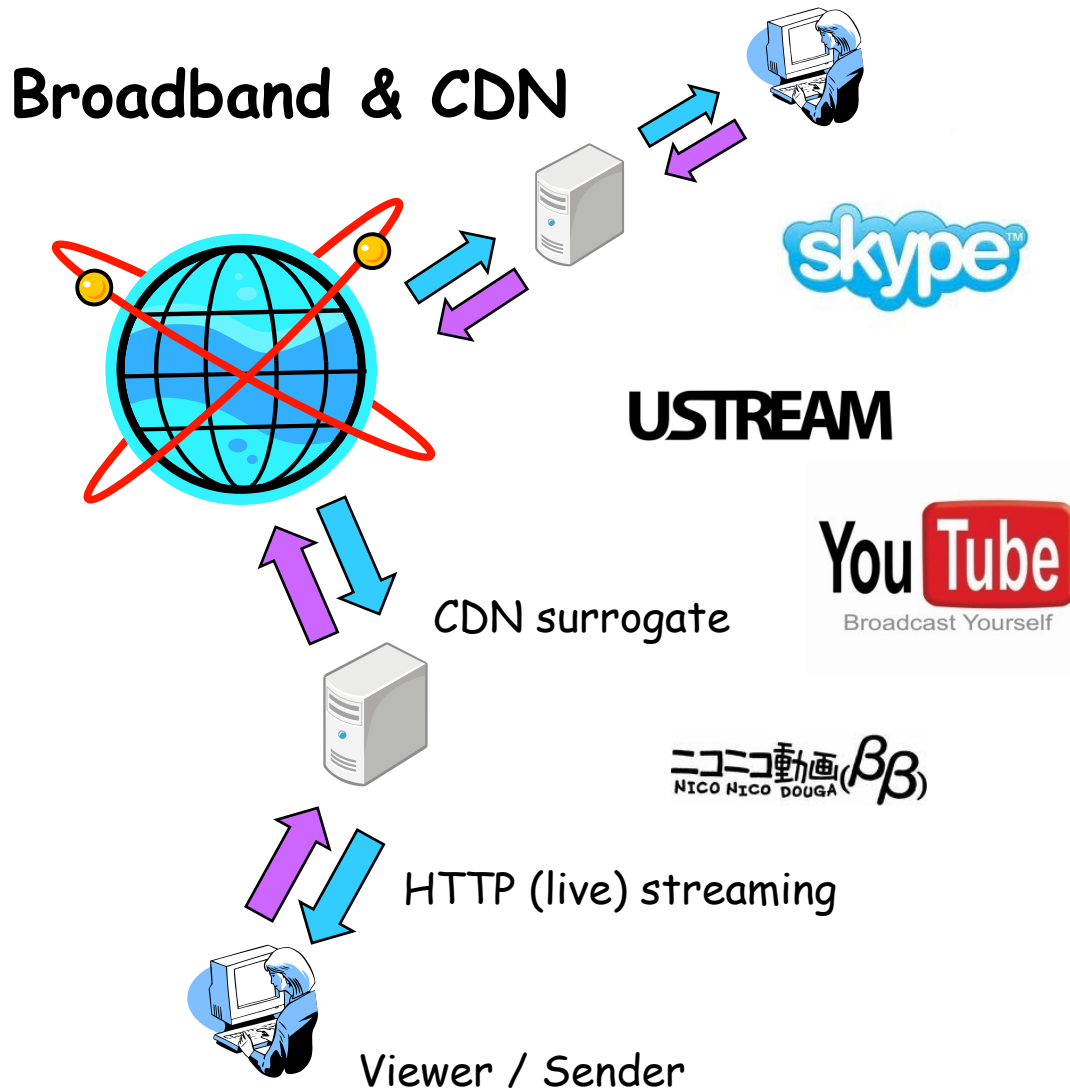

RTP/UDP & RTSP & TFRC

→ HTTP/TCP streaming

- Broadband
- CDN (Akamai, Lime Networks)
- Firewall (port 80)
- ...

One-way (on-demand / live)

- large buffer

Bi-directional (interactive)

- small buffer

CDN: Content Delivery Network ⇒ Cloud

IP Video Services

Services	Examples
IP phone & conference (interactive)	Telecommunication (SIP, H.323)
IPTV (one-way)	CATV, Telecommunication (MPEG-2 TS)
Web conferencing (interactive)	Zoom, Cisco WebEx, Skype, Google Hangout, etc ...
Video streaming (one-way)	YouTube, Amazon Prime Video, Facebook, etc ...

Protocol Transition

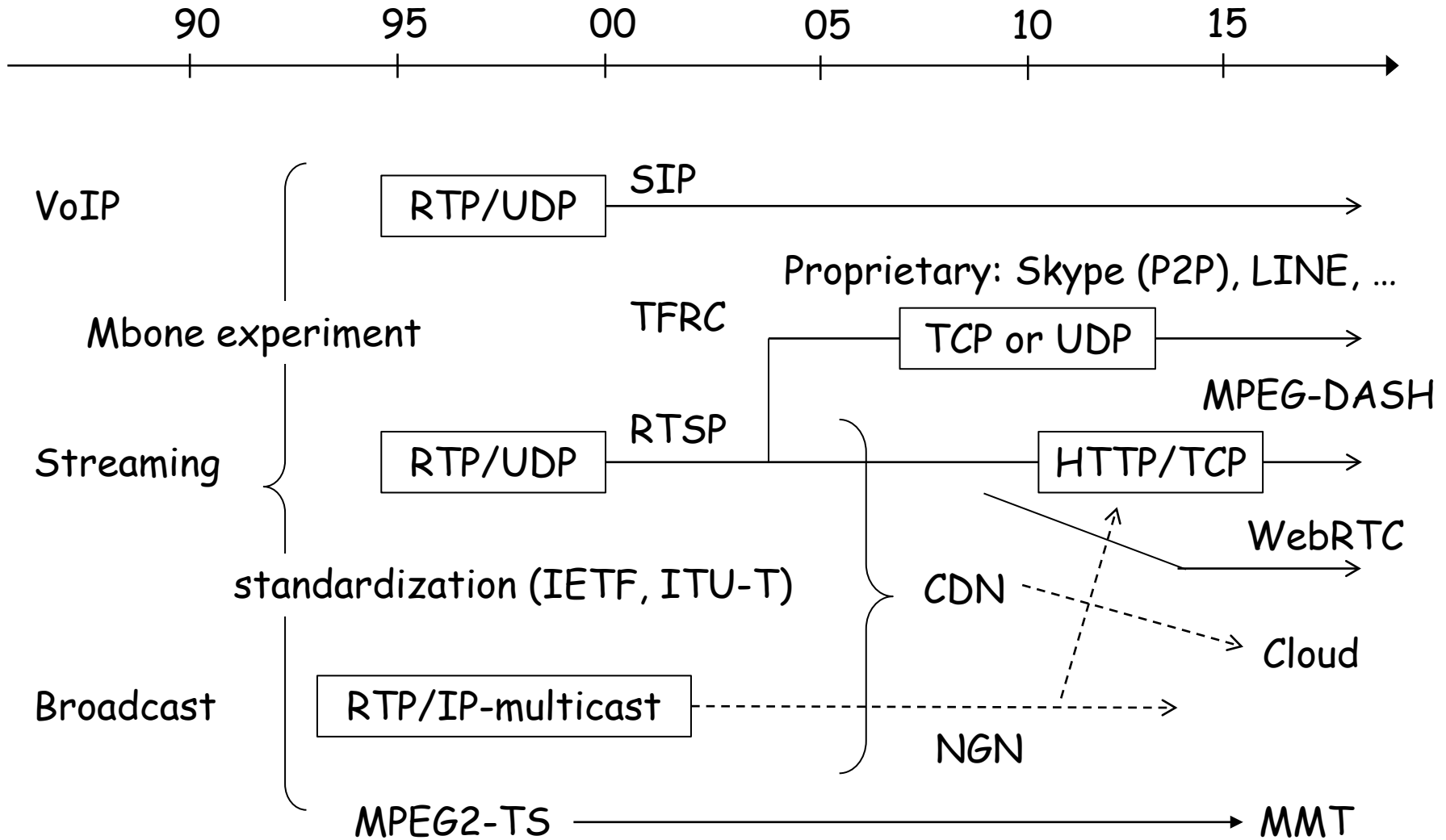

TCP vs. UDP

	Reliability	Low Delay	Congestion Control	Typical Application
TCP	◎ (ACK and lost packet retransmission)	× → ○ (thanks to CDN & broadband network)	○ → ◎ (TCP versions)	One way (on-demand) streaming
UDP	× (no ACK nor sequence number)	◎ (no ACK nor packet retransmission)	× → △ (RTP/RTCP and TFRC)	Interactive (bi-directional) phone & conference

one-way streaming in 20 years ago

prefetching & CBR

(prefetch, then CBR)

sequence
number



Live

On-Demand

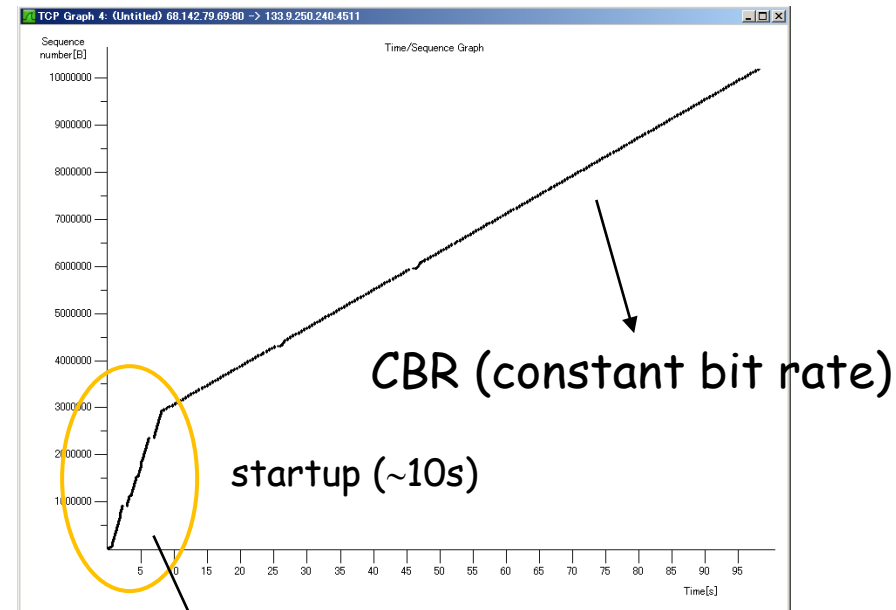
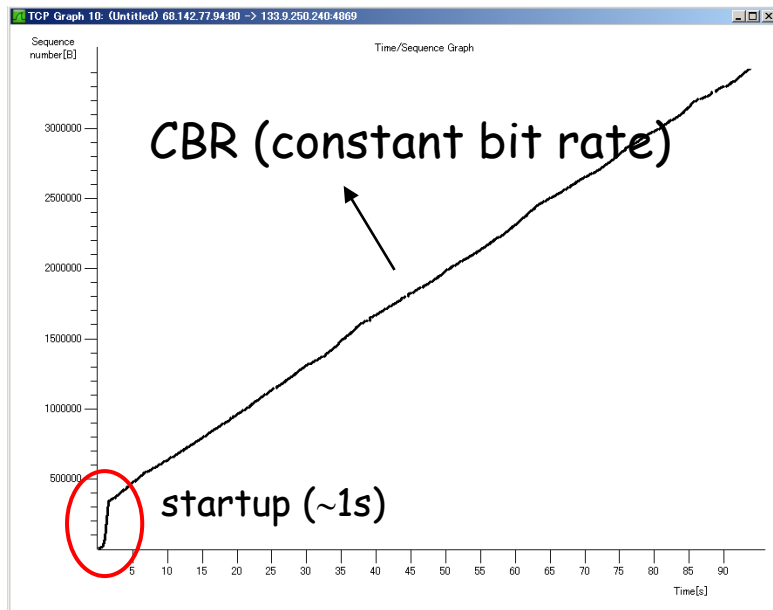

time

prefetching

ON/OFF cycles

(prefetch & idle cycles)

- receiver buffer behaviors

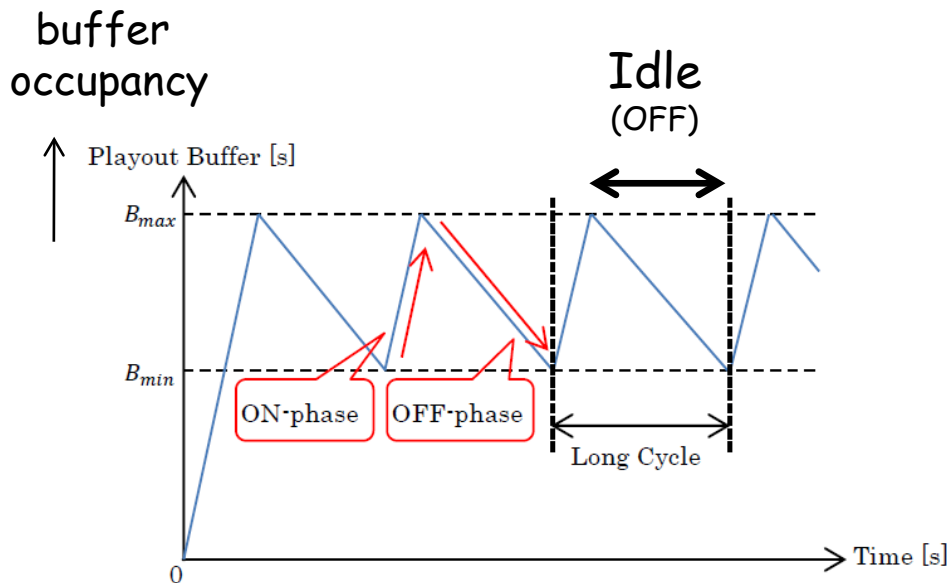

(a) long ON-OFF Cycle (sawtooth)

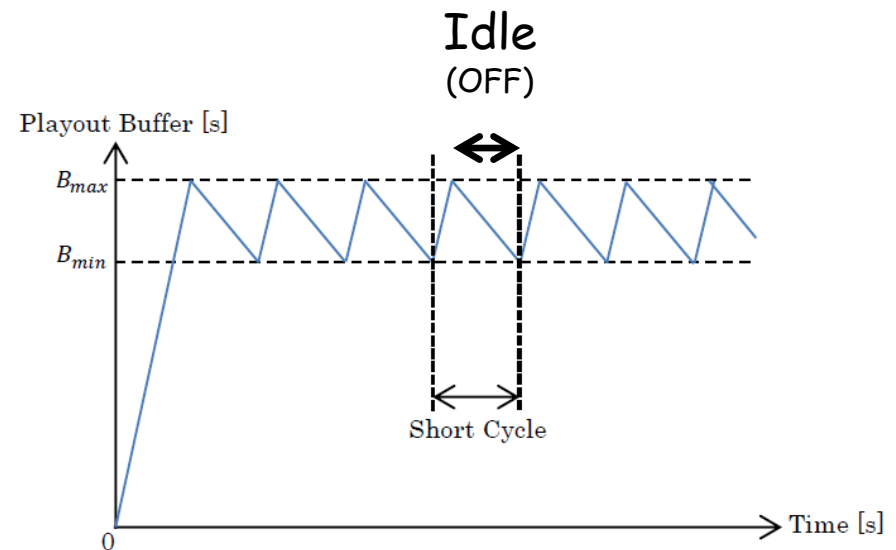

(b) short ON-OFF Cycle (zippy pacing)

one-way streaming nowadays

ON/OFF cycles

- sequence number behaviors

sequence
number

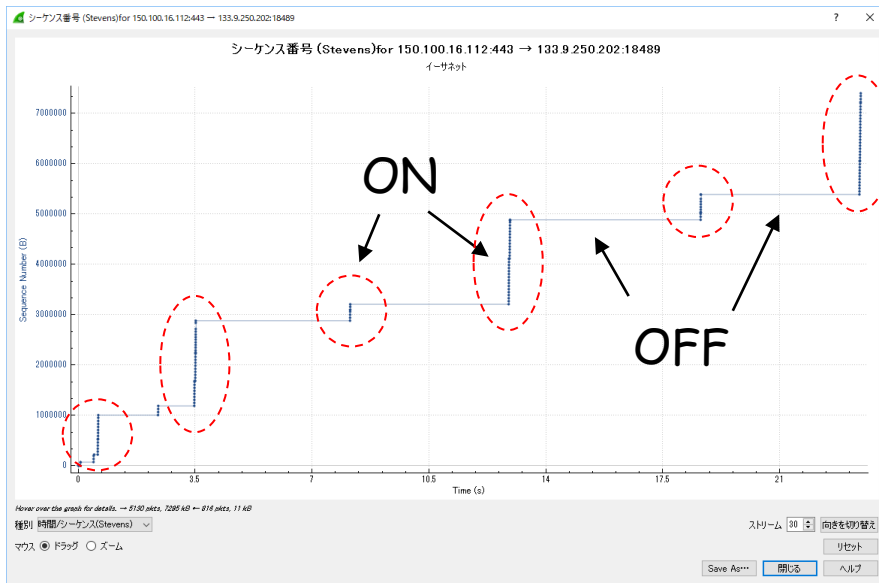

example 1 (YouTube)

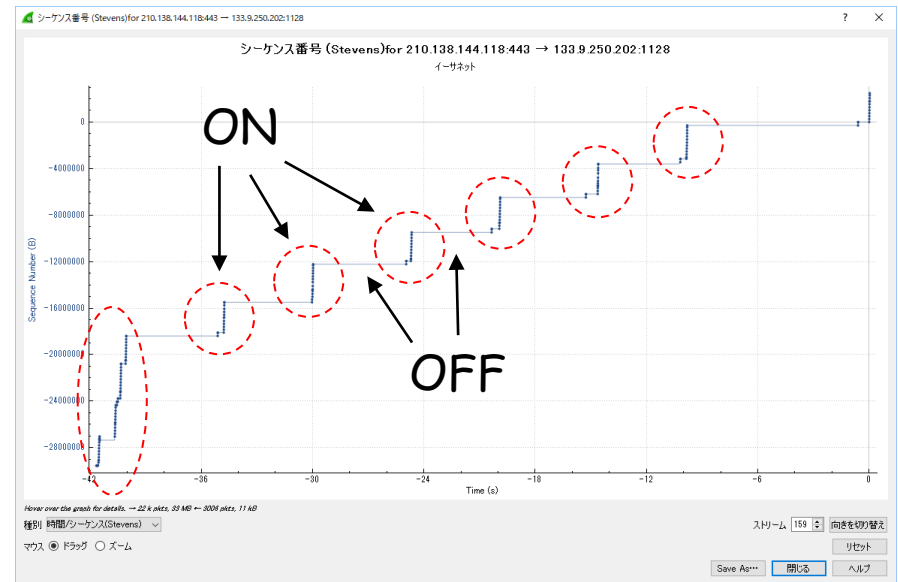

example 2 (TVer)

This year's schedule
(tentative)

This Year's Schedule

tentative

(Apr 8)	Class overview and backgrounds of video streaming
(Apr 15)	TCP variants
(Apr 22)	RTP and TFRC over UDP
(May 6)	HTTP and MPEG-DASH
(May 13)	CDN, P2P and Cloud
(May 20)	SIP and WebRTC
(May 27)	Other topics and online test
(June 3)	Video compression basics
(June 10)	H.264/AVC
(June 17)	HEVC/H.265 and VVC/H.266
(June 24)	Learned image compression
(July 1)	Image quality assessment
(July 8)	Point cloud compression
(July 15)	Class summary and online test
on Moodle	Final report